

SHARP

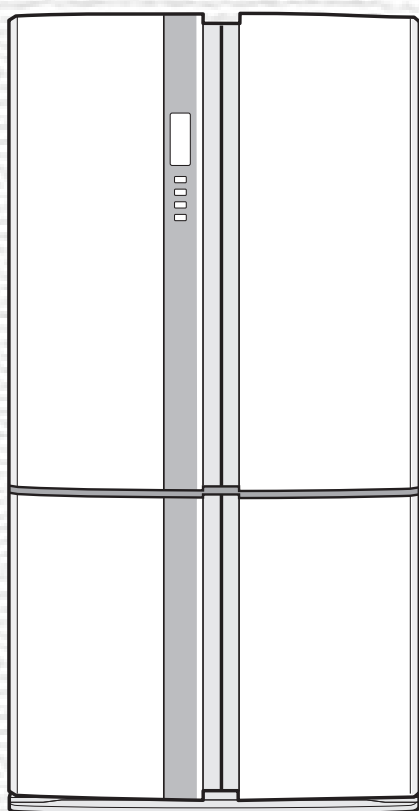

REFRIGERATOR - FREEZER OPERATION MANUAL

CONTENTS

• WARNING	3
• CAUTION	3
• INSTALLATION	4
• DESCRIPTION	5
• OPERATION	7
• STORING FOOD	11
• CARE AND CLEANING	12
• REPLACING THE PLUG	13
• BEFORE YOU CALL FOR SERVICE	14



Device of this mark is a trademark of Sharp Corporation.
Plasmacluster is a registered trademark or a trademark of Sharp Corporation.

SJ-FP813V

Thank you very much for buying this SHARP product. Before using your SHARP refrigerator, please read this operation manual to ensure that you gain the maximum benefit from it.

Household use only

- This refrigerator is for household only, with ambient temperature between +5°C and +43°C. The refrigerator should not be subjected to temperatures of -10°C or below for a long period of time.

WARNING

- This refrigerator contains flammable refrigerant (R600a: isobutane) and insulation blowing gas (cyclopentane). Observe the following rules to prevent ignition and explosion.
 - The refrigeration system behind and inside the refrigerator contains refrigerant. Do not allow any sharp objects to come into contact with the refrigeration system.
 - Do not use mechanical devices or other means to accelerate the defrosting process. (This refrigerator has an adopted automatic defrosting system.)
 - Do not use electric appliances inside the refrigerator.
 - Use only the specified parts when replacing the refrigerator compartment light.
 - Do not block the openings on the circumference of the refrigerator.
 - Do not use flammable sprays, such as spray paint near the refrigerator. It may cause explosion or fire.
 - If the refrigeration system should get punctured, do not touch the wall outlet and do not use open flames. Open the window and air out the room. Then ask a service agent approved by SHARP for servicing.
 - This refrigerator should be disposed appropriately. Take the refrigerator to a recycling plant for flammable refrigerant and insulation blowing gases.
- Do not store highly volatile and flammable materials such as ether, petrol, propane gas, aerosol cans, adhesive agents and pure alcohol etc. These materials are liable to explode.
- Dust deposited on the power plug may cause fire. Wipe it off carefully.
- Do not attempt to change or modify this refrigerator. This may result in fire, electric shock or injury.
- Ensure that the refrigerator presents no danger to children while being stored for disposal. (e.g. remove the magnetic door seals to prevent child entrapment.)

CAUTION

- Do not touch the compressor unit or its peripheral parts, as they become extremely hot during operation and the metal edges may cause injury.
- Do not touch food or metal containers in the freezer compartment with your wet hands. This may cause frostbite.
- Do not use an extension cord or adapter plug.
- Do not place bottled and canned drinks in the freezer as they may crack when frozen.
- Make sure that the power cord has not been damaged during installation or moving. If the power plug or cord is loose, do not insert the power plug. There is a risk of electric shock or fire.
- Disconnect from the mains electricity supply by removing the mains plug from the electricity supply socket. Do not remove by pulling the mains lead. This may cause electric shock or fire.
- The refrigeration system behind and inside the refrigerator contains refrigerant. Do not allow any sharp objects to come into contact with the refrigeration system.
- In case of gas leak, ventilate the area by opening a window, etc. Do not touch the refrigerator or the power outlet.
- Do not place objects containing liquid or unsteady objects on top of refrigerator.

IMPORTANT

- Should the flexible supply cord be damaged, it must be replaced by service agent approved by SHARP as a special cord is required.
- This appliance can be used by children aged from 8 years and above and persons with reduced physical, sensory or mental capabilities or lack of experience and knowledge if they have been given supervision or instruction concerning use of the appliance in a safe way and understand the hazards involved. Children shall not play with the appliance. Cleaning and user maintenance shall not be made by children without supervision.

Information on Disposal for Users (private households)



Attention:
Your product is marked with this symbol. It means that used electrical and electronic products should not be mixed with general household waste. There is a separate collection system for these products.

1. In the European Union

Attention: If you want to dispose of this equipment, please do not use the ordinary dust bin! Used electrical and electronic equipment must be treated separately and in accordance with legislation that requires proper treatment, recovery and recycling of used electrical and electronic equipment.

Following the implementation by member states private households within the EU states may return their used electrical and electronic equipment to designated collection facilities free of charge*. In some countries* your local retailer may also take back your old product free of charge if you purchase a similar new one.

*) Please contact your local authority for further details.

If your used electrical or electronic equipment has batteries or accumulators, please dispose of these separately beforehand according to local requirements.

By disposing of this product correctly you will help ensure that the waste undergoes the necessary treatment, recovery and recycling and thus prevent potential negative effects on the environment and human health which could otherwise arise due to inappropriate waste handling.

2. In other Countries outside the EU

If you wish to discard this product, please contact your local authorities and ask for the correct method of disposal.

For Switzerland: Used electrical or electronic equipment can be returned free of charge to the dealer, even if you don't purchase a new product. Further collection facilities are listed on the homepage of www.swico.ch or www.sens.ch.

WARNING

- Do not install the refrigerator in a damp or wet location as this may cause damage to the insulation and a leakage. Condensation may also build on the outer cabinet and cause rust.

1 Keep adequate ventilation space around the refrigerator.

- The figure shows the minimum required space for installing the refrigerator. (Please note that power consumption is measured in a different environment.)
- By keeping greater space, the refrigerator may be operated under a less amount of power consumption.
- If using the refrigerator in the smaller space dimension than the below figure, it may cause the temperature rise in the unit, loud noise and failure.

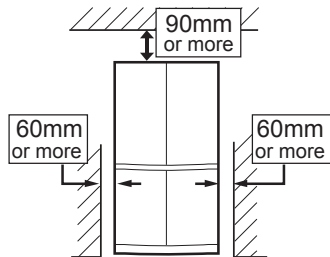

- The space between the rear of the refrigerator and the wall should be 60mm or more and less than 75mm. If the space is wider than 75mm, you may get injured by touching compressor and its peripheral parts which are extremely hot during the operation.

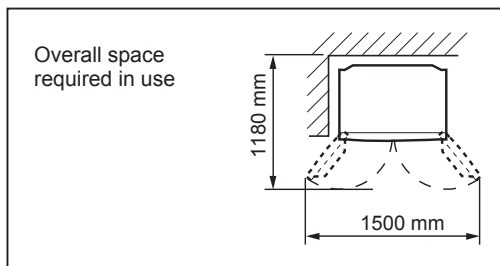

2 Use the two front adjustable feet, to ensure that the refrigerator is positioned firmly and flat on the floor.

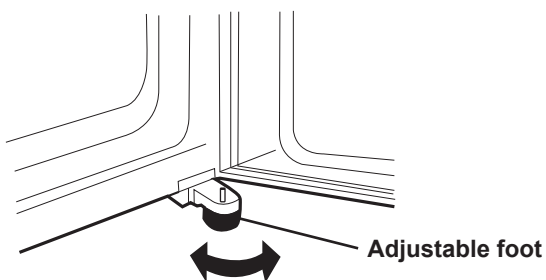

3 When right and left doors are not properly aligned, adjust using the adjustable feet.

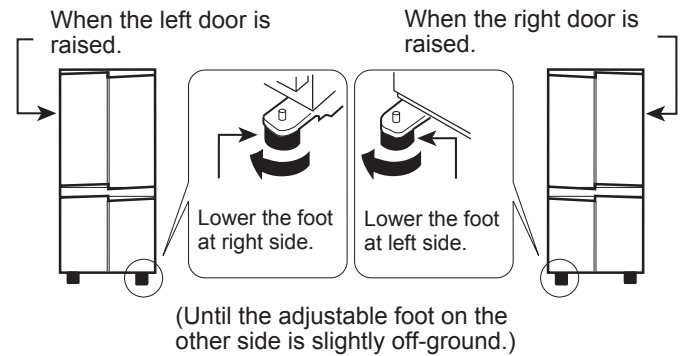

4 Remove the 4 screws of the cabinet lower part, and then set the foot cover (supplied inside the refrigerator compartment) with removed 4 screws.

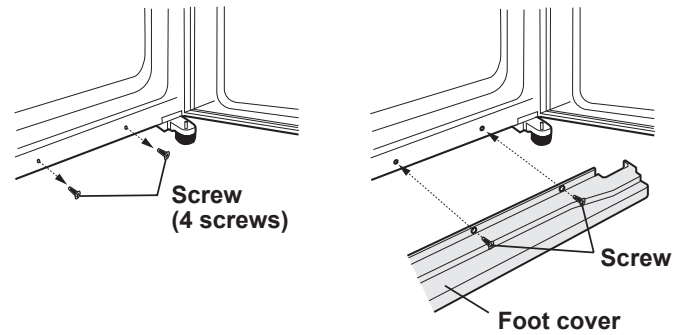

NOTE

- Position your refrigerator so that the plug is accessible.
- Keep your refrigerator out of direct sunlight.
- Do not place next to heat generating appliance.
- Do not place directly on the ground. Provide suitable stand.
- To insert the power plug when the door is opened, door alarm sounds but it is not abnormal. This sound stops when closing the door.

Before using your refrigerator

Clean the inside parts with a cloth soaked in warm water. If soapy water is used, wipe it off thoroughly with water.

DESCRIPTION

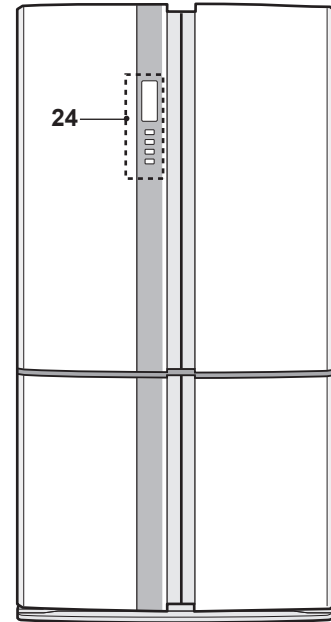
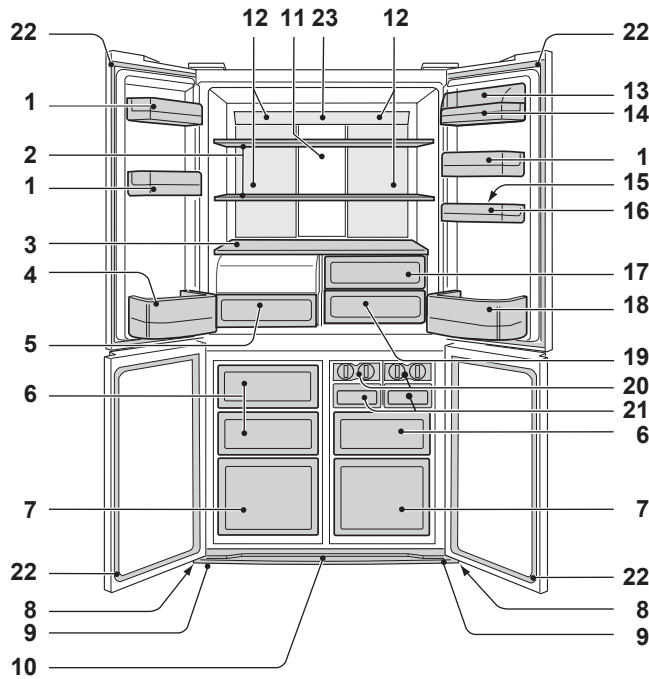

- 1. **Door pockets** (3 pcs.)
- 2. **Refrigerator shelves** (2 pcs.)
- 3. **Shelf**
- 4. **Bottle pocket (left)**
- 5. **Highly sealed vegetable crisper**
The cover of the Vegetable crisper opens as the case is pulled.
- 6. **Freezer cases (small)** (3 pcs.)
- 7. **Freezer cases (large)** (2 pcs.)
- 8. **Casters** (4 pcs.)
- 9. **Adjustable feet** (2 pcs.)

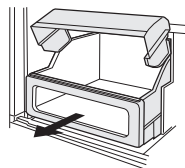

- 10. **Foot cover**
- 11. **Hybrid cooling panel**
The panel is cooled from the rear, thus indirectly cools the refrigerator compartment. In this way, food is refrigerated gently, without exposing it to the cold air flow.

- 12. **Light**
- 13. **Utility pocket cover**
- 14. **Utility pocket**
- 15. **Egg holder**
- 16. **Egg pocket**
- 17. **Fruit case**
- 18. **Bottle pocket (right)**

To store large-size bottles, move the partition all the way back.

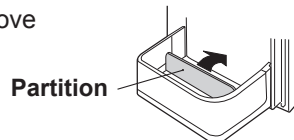

- 19. **Fresh case**

- 20. **Ice cube maker** (2 pcs.)
 - Do not over fill the tray; otherwise the ice cubes will be joined together when frozen.
 - When the ice cubes are made, turn the lever clockwise to empty the ice into the Ice cube box.

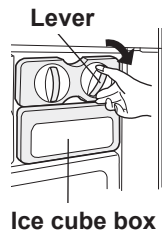

- 21. **Ice cube box** (2 pcs.)
To prevent damage to the Ice cube box, do not make ice in the Ice cube box or pour oil into it.

- 22. **Magnetic door seals** (4 pcs.)
- 23. **Eco sign**

With the refrigerator door is left open, the lamp will slowly change its color from blue to orange. This shows the temperature in the refrigerator is rising.

- 24. **Control panel**

Deodorizing unit

Deodorizing catalyst is installed on the routes of cold air. No operation and cleaning are required.

More food can be stored by taking out the internal accessories with duly cooling.

How to remove
To remove the partition, pull it to the front with pushing the claw.

How to set
Insert the four projections into the upper parts.

Control panel

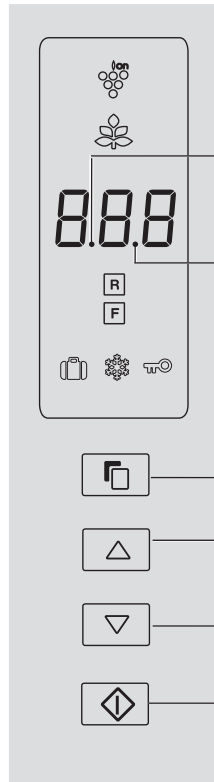

Sound OFF indication

This indication shows sound "OFF".

Door alarm indication

This indication shows door alarm "ON".

Select button

Press to select feature icon and door alarm signal.

▽ / △ button





Press to select feature ON/OFF or temperature setting.

◇ (Enter) button



Finalise the setting.

Feature icons

Icons of features in operation are displayed.

-  **Plasmacluster**
-  **Energy saving**
-  **Vacation mode**
-  **Express Freezing**
-  **Child lock**

Controlling temperature icons

-  **Refrigerator compartment**
-  **Freezer compartment**

NOTE

- Features start automatically like right figure when inserting the power plug. (At first, only Door alarm is "ON").
- When there is no operation for approx. 1 minute the display automatically return to the standby display. Additionally, the display will be turned off when there is no operation for 1 minute.
- When either of the button is pressed, the icons are blink once and show the standby display. When the refrigerator stops with power failure, the display shows similarly as before having a power failure at the time of <Standby display> re-power distribution. However, when it has a power failure during operation of Express Freezing, the operation is stopped at the time of re-power distribution.



Sound ON/OFF

- At first, the sound is set "ON".
- Use this feature when you want to switch the sound of button operation to "ON" or "OFF".

To set sound "OFF"

Press the ▽ button and ◇ button simultaneously and continuously for 3 seconds or more.

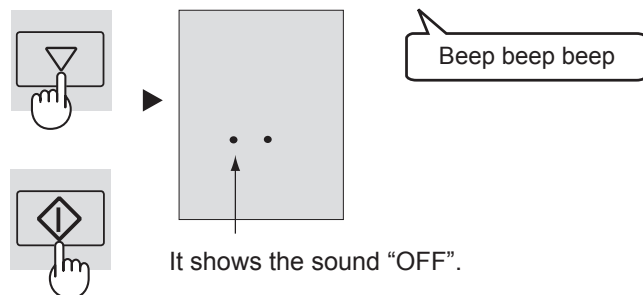

To set sound "ON"

Press the ▽ button and ◇ button simultaneously and continuously for 3 seconds or more again.

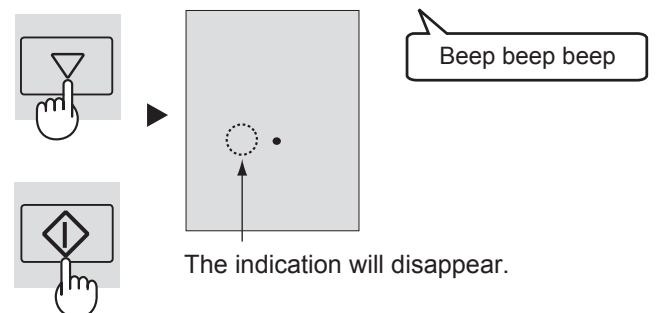

OPERATION

Plasmacluster

The ionizer inside the refrigerator release clusters of positive and negative ions, into the refrigerator compartment. These ion clusters inactivate airborne mould fungus.

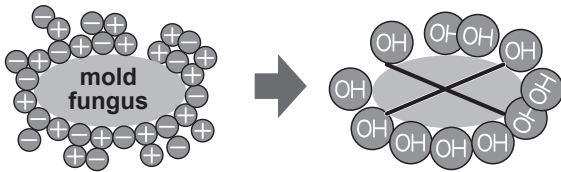

To start operation

- 1 Select "Plasmacluster icon".

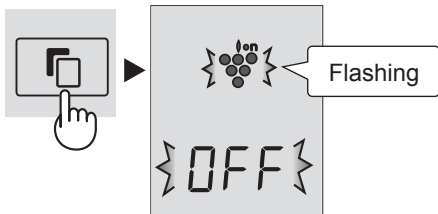

- 2 Select "ON".

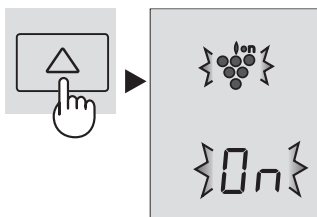

- 3 Finalise the setting.

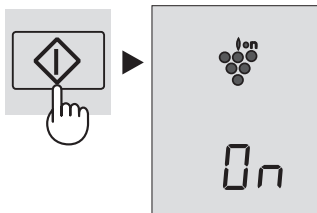

To cancel operation

It is the same process as activating this function. Select "OFF" in step 2.

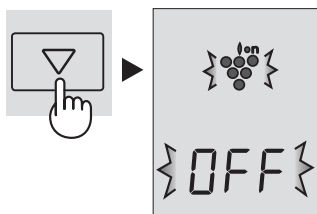

NOTE

- There may be a slight odour in the refrigerator. This is the smell of ozone generated by the ionizer. The amount of ozone is minimal, and quickly decomposes in the refrigerator.

Energy Saving

Use this feature when you want to switch the appliance to energy-saving operation.

To start operation

- 1 Select "Energy saving" icon.

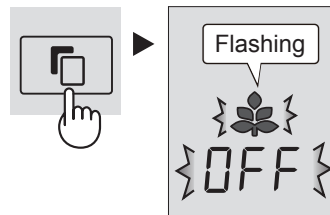

- 2 Select "ON".

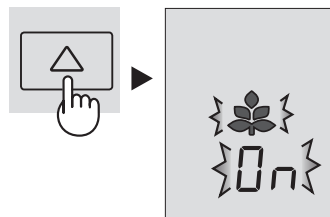

- 3 Finalise the setting.

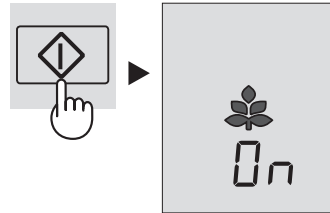

To cancel operation

It is the same process as activating this function. Select "OFF" in step 2.

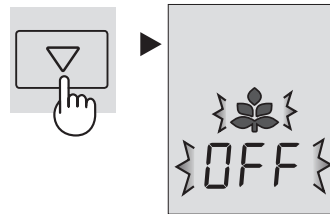

NOTE

- While this feature is operating, the inside temperature of the refrigerator and freezer compartment will be higher than the preset temperature by about 1°C (refrigerator) and about 2°C (freezer). This is the guide under the condition of the preset temperature 3°C (refrigerator) and -18°C (freezer). The display of preset temperature will not be changed.
- The efficiency of power saving depends on the usage environment (controlling temperature, ambient temperature, frequency of opening or closing the door, amount of food).
- Cancel this feature when you feel the beverages are not cooled enough or ice making takes time.

Vacation mode

Use this feature when going on a trip or leaving the house for long periods of time.

To start operation

- 1 Select "Vacation mode" icon.

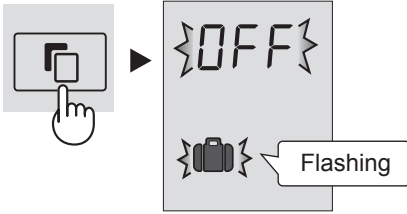

- 2 Select "ON".

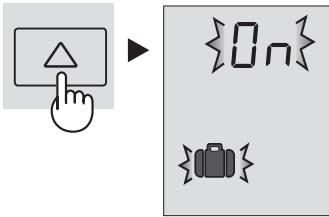

- 3 Finalise the setting.

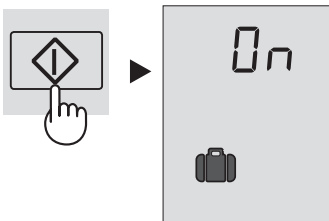

To cancel operation

It is the same process as activating this function. Select "OFF" in step 2.

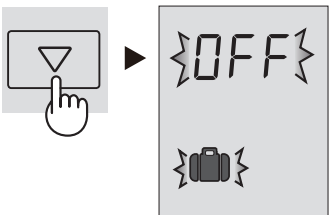

NOTE

- The temperature inside the refrigerator compartment will be adjusted to about 10°C.
- Food storage period in the refrigerator compartment becomes approx. 1/2-1/3 of normal operation. Please utilise only when there is no perishable food.
- Temperature of refrigerator compartment cannot be modified. ("10°C" is indicated on the display.)

Express Freezing

Express freezing is so convenient for home-freezing.

To start operation

- 1 Select "Express freezing" icon.

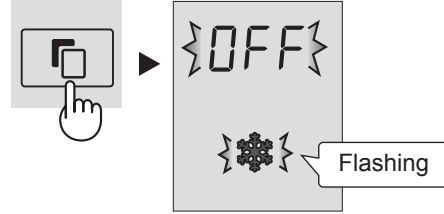

- 2 Select "ON".

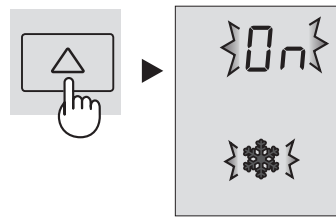

- 3 Finalise the setting.

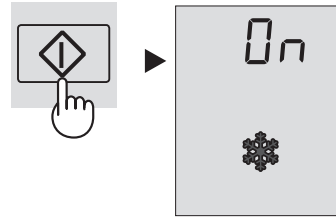

To cancel operation

It is the same process as activating this function. Select "OFF" in step 2.

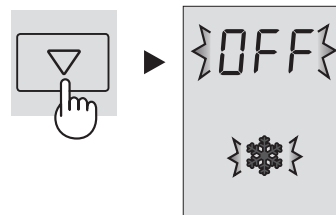

NOTE

- Express Freezing ends automatically in approx. 2 hours. (The icon will disappear.)
- Large quantities of food cannot be frozen in a single operation.
- Express freezing cannot be activated if its operation overlaps with defrosting. In this case, express freezing may require more than 2 hours as the operation is started after defrosting is completed.
- Open the door as little as possible whilst the Express Freezing is active.

Child Lock

Button operation of the control panel will be locked. Use this feature to prevent the panel from being used unintentionally.

To start operation

- 1 Select "Child lock" icon.

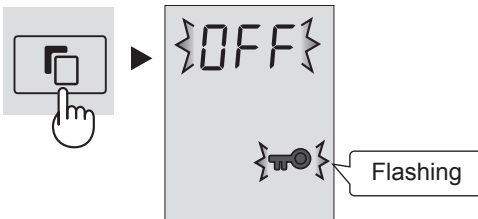

- 2 Select "ON".

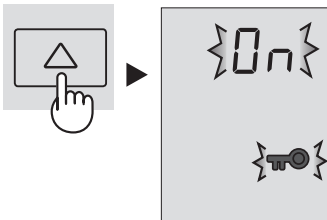

- 3 Finalise the setting.

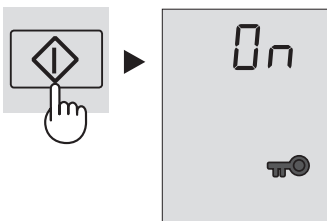

To cancel operation

It is the same process as activating this function. Select "OFF" in step 2.

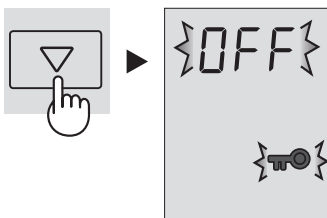

Door Alarm

- Factory has set the door alarm to "ON".
- If the refrigerator door is left open, the door alarm will sound.
- The door alarm will sound after 1 minute of opening the door and again after a further minute has passed. (Once in each case)
- If the door is left open for approx. 3 minutes, the alarm will sound continuously.

To cancel operation

- 1 Select the door alarm indication like the below figure.

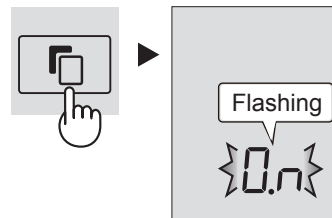

- 2 Select "OFF".

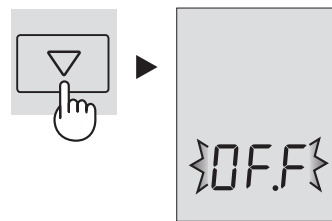

- 3 Finalise the setting.

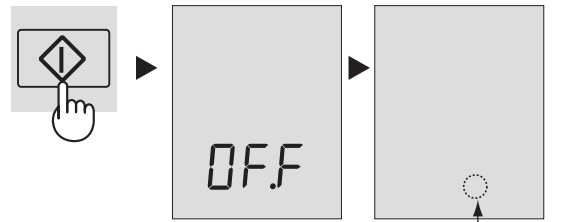

The indication will disappear.

To start operation

It is the same method as cancelling operation. Select "ON" in step 2.

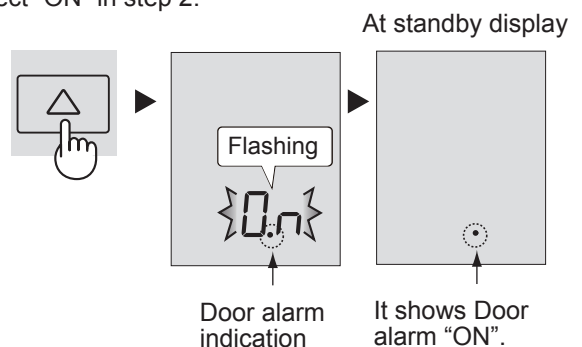

R Controlling Temperature

F

The refrigerator controls its temperature automatically. However, if needed, adjust the temperature as follows.

Refrigerator compartment

Adjustable between 0°C and 6°C in steps of 1°C.

- 1 Select **R** icon.
The display shows the current preset temperature.

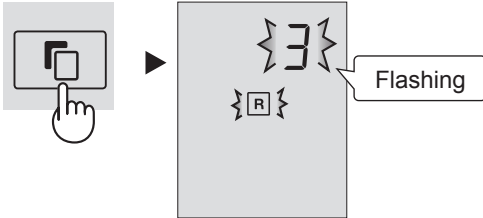

- 2 Set the temperature.
[Δ : increase, ∇ : decrease]

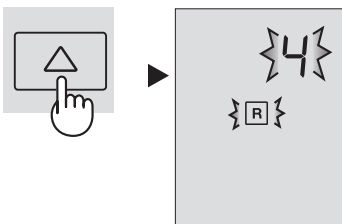

- 3 Finalise the setting.

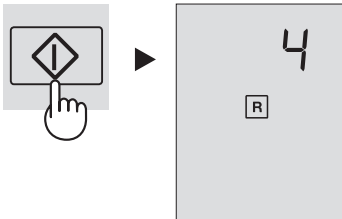

Freezer compartment

Adjustable between -13°C and -21°C in steps of 1°C.

- 1 Select **F** icon.
The display shows the current preset temperature.

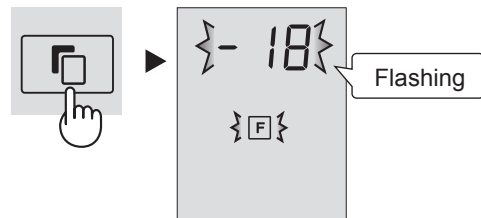

- 2 Set the temperature.
[Δ : increase, ∇ : decrease]

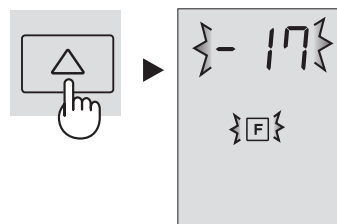

- 3 Finalise the setting.

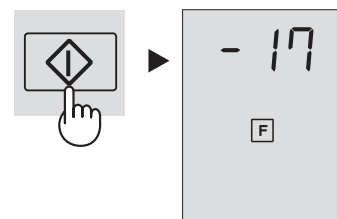

Advanced Setting of Freezer / Refrigerator compartment

The temperature of freezer compartment and refrigerator compartment can be adjusted in steps of 0.5 °C by following steps 1 to 3 below.

Refrigerator compartment

1. Select **R** icon.
2. Press \blacklozenge button continuously for 3 seconds or more.
The current preset temperature on the display will be changed to 3.0 °C.
(The display will be indicated like right figure.)
3. Adjust the temperature in the same way as steps 2 to 3 above.

Beep beep beep



Follow steps 1 to 2 again if you want to adjust the temperature in steps of 1°C.

Freezer compartment

1. Select **F** icon.
2. Press \blacklozenge button continuously for 3 seconds or more.
The current preset temperature on the display will be changed to -18.0 °C.
(The display will be indicated alternately like right figure.)
3. Adjust the temperature in the same way as steps 2 to 3 above.

Beep beep beep

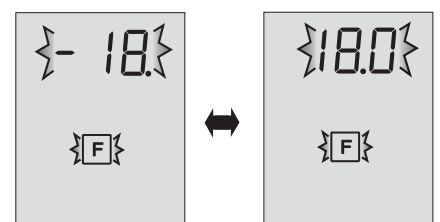

Follow steps 1 to 2 again if you want to adjust the temperature in steps of 1°C.

STORING FOOD

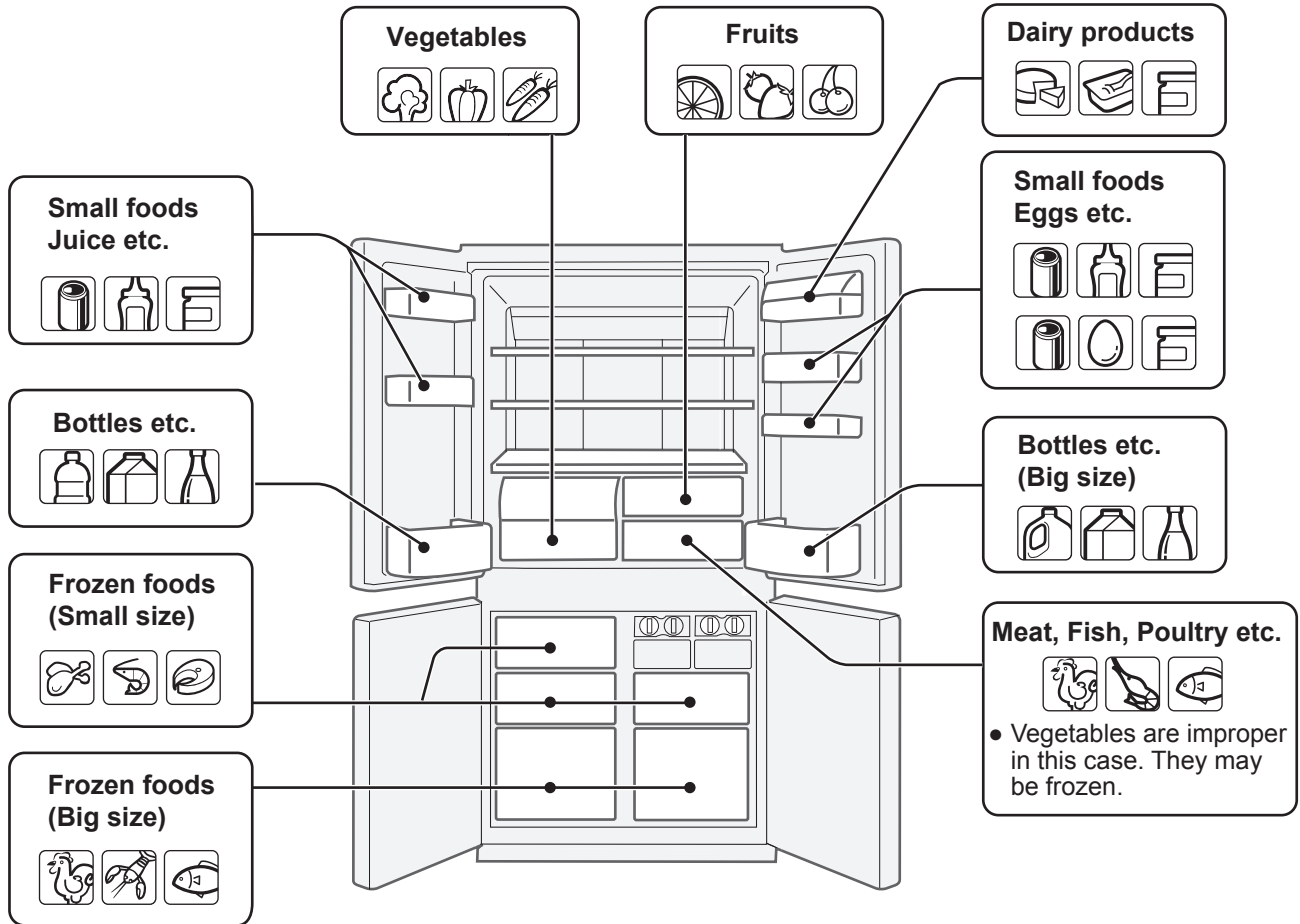

Refrigeration reduces the rate of food spoilage. To maximise the shelf life of perishable food products, ensure that the food is of the freshest possible quality. The following is a general guide to help promote longer food storage.

Fruit / Vegetables

To minimize moisture loss, fruit and vegetables should be loosely enclosed in a plastic material e.g. wrap, bags (do not seal) and place in the vegetable crisper or the fruit case. If you store a lot of vegetables, dew may form. This has no effect on the operation or the performance. Use a dry cloth to remove the dew.

Dairy Products & Eggs

- Most dairy products have a use by date on the outer packaging which informs the recommended temperature and shelf life of the product.
- Eggs should be stored in the Egg holder.

Meats / Fish / Poultry

- Place on a plate or dish and cover with paper or plastic wrap.
- For larger cuts of meat, fish, or poultry, place to the rear of the shelves.
- Ensure all cooked food is wrapped securely or placed in an airtight container.

NOTE

- Evenly place the food on the shelves to allow the cooling air to circulate efficiently.
- Hot foods should be cooled before storing. Storing hot foods increases the temperature in the unit and increases the risk of food spoilage.
- Do not block the outlet and inlet of the cool air circulating circuit with foods or containers; otherwise the foods will not be evenly cooled throughout the refrigerator.
- Keep the door securely closed.

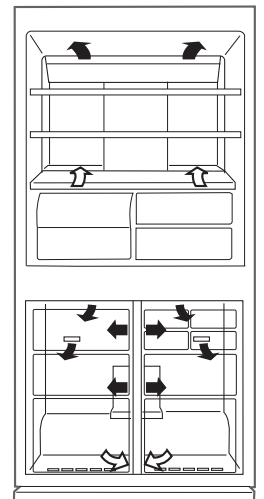

← IN
→ OUT

Do not place food directly in front of cold air outlet. This may lead to the food freezing.

For best freezing

- Quality of foods should be fresh.
- Freeze small quantities of food at a time to freeze them quickly.
- Food should be properly sealed, sealed tightly or covered.
- Evenly place the food in the freezer.
- Label bags or containers to keep an inventory of freezing food.

CARE AND CLEANING

WARNING

- Unplug the refrigerator first to prevent electric shock.
- Do not splash water directly on the outer cabinet or the interior. This may lead to rusting and deterioration of the electrical insulation.

IMPORTANT

To prevent cracking on inside surfaces and plastic components, follow these tips.

- Wipe any food oils adhered to plastic components.
- Some household chemicals may cause damage, so use only diluted washing-up liquid (soapy water).
- If undiluted detergent is used or soapy water is not wiped off thoroughly, cracking of plastic parts can result.

- 1 Remove the accessories e.g. shelves from the cabinet and door. Wash them in warm soapy dishwashing water; rinse in clean water and dry.
- 2 Clean the inside with a cloth soaked in warm soapy dishwashing water. Then, use cold water to wipe off soapy water.
- 3 Wipe the exterior with a soft cloth each time it is soiled.
- 4 Clean the Magnetic door seal with a toothbrush and warm soapy dishwashing water.
- 5 Wipe the control panel with the dry cloth.

NOTE

- To prevent damage to your refrigerator, do not use heavy duty cleansers or solvents (lacquer, paint, polishing powder, benzine, boiled water, etc.).
- If the power supply is disconnected, please wait for at least 5 minutes before re-connecting power.
- The glass shelves weigh approximately 3 kg each. Hold firmly when removing from the cabinet or carrying.
- Do not drop objects inside the refrigerator or strike the inner wall. This may cause the inner surface to crack.

Defrosting

Defrosting is fully automatic due to a unique energy saving system.

Tips for saving energy

- Keep the ventilation space as much as possible around the refrigerator.
- Keep your refrigerator out of direct sunlight, and do not place next to a heat generating appliance.
- Open your refrigerator door as little as possible.
- Hot foods should be cooled before storing.
- Place the food evenly on the shelves to allow the cooling air to circulate efficiently.

When the compartment light is blown

Contact the service agent approved by SHARP to request a replacement compartment light. The compartment light is not to be removed other than by qualified service personnel.

When transporting

- Wipe up water in the evaporating pan. Before wiping up the water, wait more than 1 hour after pulling out the plug because refrigeration cycle equipment is extremely hot. (The evaporating pan is located on the rear of the product.)

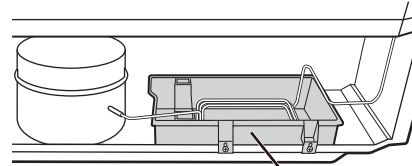

Evaporating pan

- The casters allow the refrigerator to move back and forth.



Casters

- Carry the refrigerator by holding the handles located on the rear and bottom.

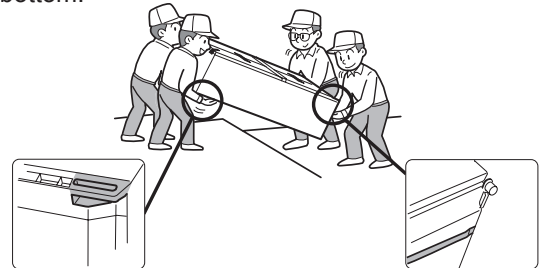

Switching off your refrigerator

If you switch your refrigerator off when you are going away for an extended period, remove all food, clean the interior thoroughly. Remove the power cord plug from the power socket and leave all doors open.

The amount of power consumption of this model is measured according to the international standard of the refrigerator performance under the following conditions.

- All accessories in the freezer compartment are taken out as indicated on the figure.

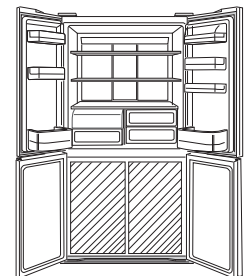

- Space dimensions.

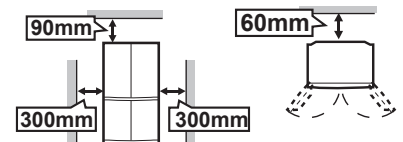

REPLACING THE PLUG

The mains lead of this product is fitted with a non-rewireable plug incorporating a 13A fuse. Should the fuse need to be replaced, a BSI or ASTA approved 13A fuse should be used.

IMPORTANT : Never use the plug without the fuse cover fitted.

If the fitted plug is not suitable for your socket outlets, remove the fuse from the plug then cut-off the plug from the cable.

IMPORTANT : Dispose of the cut-off plug immediately and safely.

To fit an appropriate plug to the mains lead, follow the instructions below:

IMPORTANT

The wires in this mains lead are coloured in accordance with the following code:

GREEN-AND-YELLOW : Earth
BLUE : Neutral
BROWN : Live

As the colours of the wires in the mains lead of this apparatus may not correspond with the coloured markings identifying the terminals in your plug proceed as follows.

- The wire which is coloured **GREEN-AND-YELLOW** must be connected to the terminal in the plug which is marked by the letter **E** or by safety earth symbol \perp or coloured green or green-and-yellow.
- The wire which is coloured **BLUE** must be connected to the terminal which is marked with the letter **N** or coloured black.
- The wire which is coloured **BROWN** must be connected to the terminal which is marked with the letter **L** or coloured red.

This apparatus must be protected by a 13A fuse in the mains plug or distribution board.

WARNING : THIS APPARATUS MUST BE EARTHED.

If you have any doubt, consult a qualified electrician.

BEFORE YOU CALL FOR SERVICE

Before you call for service, check the following points.

Problem	Solution
The outside of the cabinet is hot when touched.	It is normal. The hot pipe is in the cabinet in order to prevent dew generation.
When there is refrigerator noise.	It is normal for the refrigerator to produce the following sounds. <ul style="list-style-type: none">• Loud noise produced by the compressor when operation starts<ul style="list-style-type: none">--- Sound becomes quieter after a while.• Loud noise produced once a day by the compressor<ul style="list-style-type: none">--- Operating sound produced immediately after automatic defrost operation.• Sound of flowing fluid (gurgling sound, fizzing sound)<ul style="list-style-type: none">--- Sound of refrigerant flowing in pipes (sound may become louder from time to time).• Cracking or crunching sound, squeaking sound<ul style="list-style-type: none">--- Sound produced by expansion and contraction of inner walls and internal parts during cooling.
Frosting or dew generation occurs inside or outside the refrigerator.	This may occur in one of the following cases. Use a wet cloth for wiping frost and a dry cloth for wiping dew. <ul style="list-style-type: none">• When the ambient humidity is high.• When the door is frequently opened and closed.• When food containing plenty of moisture is stored. (Wrapping is required.)
Food in the refrigerator compartment freeze.	<ul style="list-style-type: none">• Is the refrigerator operated for a long time with refrigerator temp. control set at 0°C?• Is the refrigerator operated for a long time with freezer temp. control set at -21°C?• Low ambient temperatures may cause placed foods to freeze even if the refrigerator temp. control is set to 6°C.
It smells in the compartment.	<ul style="list-style-type: none">• Wrapping is required for the foods with strong smell.• Deodorizing unit cannot remove all of the smell.

IF YOU STILL REQUIRE SERVICE

Refer to your nearest service agent approved by SHARP. (tel : 0845 882 0025)

GUARANTEE

Subject to the conditions listed below Sharp Electronics Europe Ltd. (here in after called "the Company") guarantee to provide for the repair of, or at its option replace this Sharp Equipment, or any component thereof, which is faulty or below standard, as a result of inferior workmanship or materials.

1. This Guarantee shall only apply to defects or faults which are notified to the Company, or its approved Service Facility within two years from the date of purchase of the equipment.
2. This guarantee covers equipment intended for domestic use only. This guarantee does not apply to equipment used in the course of a business, trade or profession.
3. This guarantee does not cover any faults or defects caused by accident, misuse, fair wear and tear, neglect or tampering with the equipment.
4. It is a condition of this guarantee that repairs effected hereunder are carried out by a Sharp approved Service Facility. In case of service, please telephone one of the following numbers for details of after sales service.
UK 0845 882 0025
Republic of Ireland 01 676 0648
5. No person has any authority to vary the terms or conditions of this Guarantee.
6. This Guarantee is offered as an additional benefit to the customer's statutory rights and does not affect these rights in any way.

IMPORTANT NOTICE :

This guarantee only applies to product sold in the United Kingdom and the Republic of Ireland.

SHARP

SHARP CORPORATION

22-22, Nagaike-cho, Abeno-ku,
Osaka. 545-8522, Japan

In Europe represented by

SHARP ELECTRONICS EUROPE LTD.

4 Furzeground Way, Stockley Park,
Uxbridge, Middlesex, UB11 1EZ, U.K.

Printed in Thailand

TINS-B574CBRZ 14CK (TH) ①